

Brio®

Brio® where ideas unfold

Brio® Weatherfold 5c

Exterior bottom-rolling door hardware systems for folding panels up to 80kg

Brio® where ideas unfold

Watch your adventurous architectural ideas unfold into exciting reality with the Brio range of sliding and folding door hardware.

Brio is passionate about shaping the spaces in which people live, work and play. With subsidiaries in the UK and USA – Brio is recognised by architects worldwide as a leading design and manufacturing company.

Brio's R&D department brings a strong design element to the business, developing and testing ground breaking concepts that continue to be at the forefront of the industry.

So it's no surprise our name Brio translates to Energy, Spirit and Vitality – the core values that drive us to always discover new solutions for our customers.

We are committed to the continuous improvement of quality. That is why Brio, located in Sydney, is certified to Quality Management System AS/NZS ISO 9001:2015.

Brio, part of the Allegion family of brands







Brio® Weatherfold 5c

Brio brings a stylish edge to any home or commercial venue when it comes to using space more efficiently.

Exterior folding doors are without doubt the key to indoor/outdoor living. Whether you need to connect or partition an outdoor area; exterior folding doors open and close effortlessly, and stack unobtrusively to create wide open vistas.

Brio's Weatherfold series has long been recognised as the architectural standard in exterior folding door hardware. Designed in Australia, Brio Weatherfold is trusted by major window and door manufacturers worldwide.

Weatherfold 5c has been developed to handle panels up to 80kg with precision and ease. The impressive, bottom rolling hardware is suitable for metal and timber doors. A system can create openings up to 3m high and 16m wide as up to eight equal size panels can fold seamlessly in each direction.

A complete system includes pivot sets, roller sets, hinge sets, top channel, sill track, seals, locking and screening.

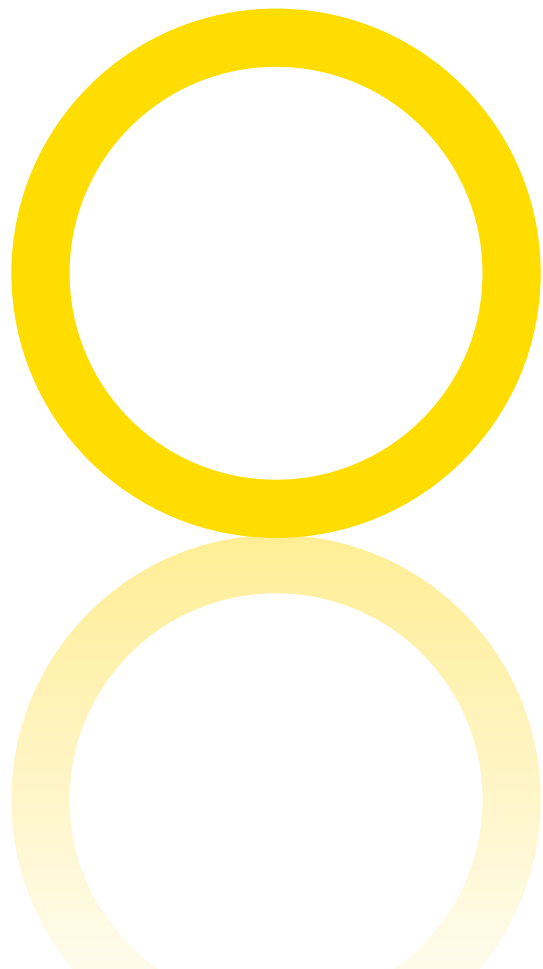



Brio® Weatherfold 5c

Exterior bottom-rolling door hardware system for folding panels up to 80kg

Brio's Weatherfold 5c system eliminates the need for a reinforced structural beam above the opening, as all the doors weight is carried by bottom rollers.

Bottom-rolling type systems are particularly favoured by architects, as the absence of the restricting top beam also means there is more room for design creativity.

Brio Weatherfold 5c is more than just a combination of individual hardware parts - it is a carefully designed system, with all features working in unison to create an incredibly functional and elegant solution to folding doors which is what our customers have come to expect from Brio.

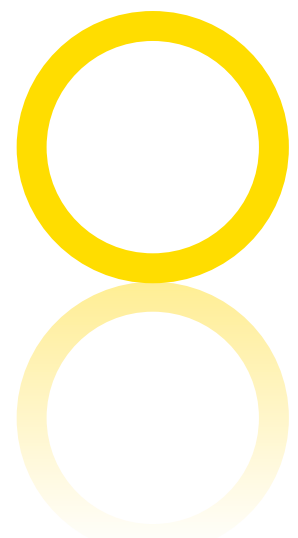



System Design Features

Evolutionary Bottom Roller Construction

Unlike other bottom-rolling folding door systems that use multi-wheel rollers, Brio Weatherfold 5c uses a large, horizontal puck for its roller. This innovative puck design consists of a stainless steel tyre and a precision bearing. The advantage of this unique system is that it is noticeably smoother to operate even at its maximum weight capacity.

Weatherfold 5c's roller is significantly larger than the wheels usually used in bottom rolling systems meaning it rotates less over the same distance. This combined with its full stainless steel construction and precision bearings, makes Brio bottom-rolling hardware extremely durable.

Self-Cleaning System

Another stand out feature of Weatherfold 5c is its patented self-cleaning technology. A brush attached to the rim of the horizontal roller sweeps and cleans the rail, as the door traverses across the opening.

The roller runs on a raised stainless steel rail, a feature that makes it difficult for most debris to balance on, therefore assisting with removal of silt and particles from the rollers' path.

The single point contact between the puck and the rail reduces rolling resistance which means the system's operation remains uncompromisingly smooth and comfortable.

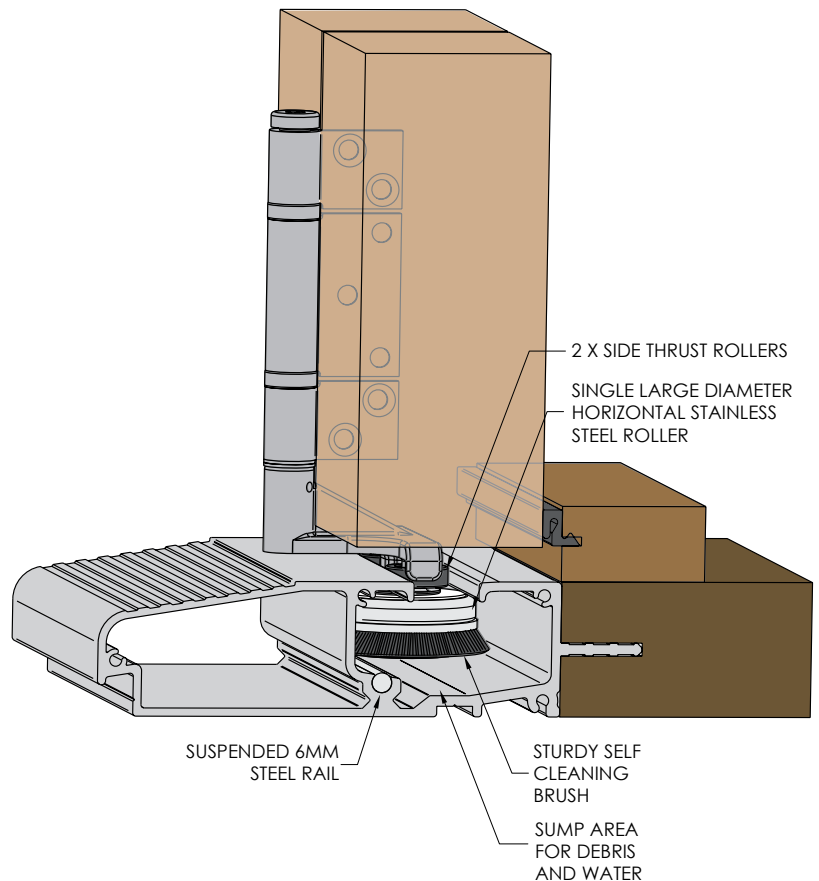

Self-Draining Sill

Brio's self-draining 98HS sills are specifically designed for Brio Weatherfold 5c bottom rolling folding door system and provide an efficient and convenient solution for floor-channel drainage.

The sills incorporate a large sump area underneath the track for collection of unwanted debris. Water drains out of the channel through predrilled slots at the front of the sill, taking the debris with it and emptying it every time water runs through.

The sills are also designed to aesthetically conceal the bottom roller out of sight, but leave enough access area for effective cleaning and maintenance when required. This feature greatly prolongs the life of the system, allowing you to enjoy the comfort of your stylish folding doors hassle-free.

A choice of sill can be made from a square, aluminium nose or a timber tread for a more traditional appearance (see page 14). Both sills allow for rebate timbers to house Brio's 612 retractable pleated insect screen (see page 16).

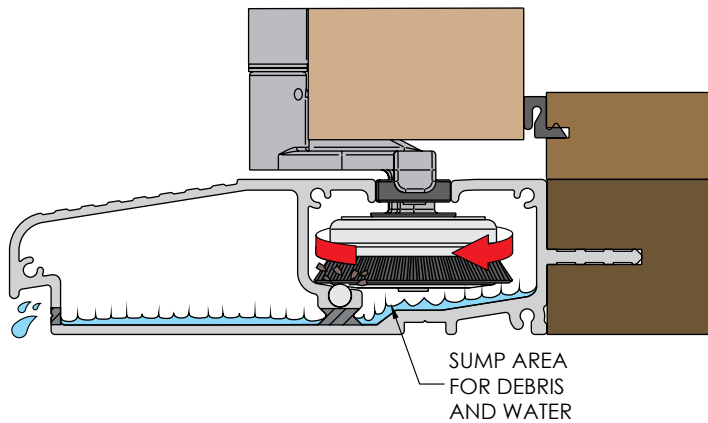

Perfect Installation

Both top and bottom pivots can be easily and accurately adjusted laterally via provided hex keys. This design feature ensures that the panels always follow the contour of the sill perfectly.

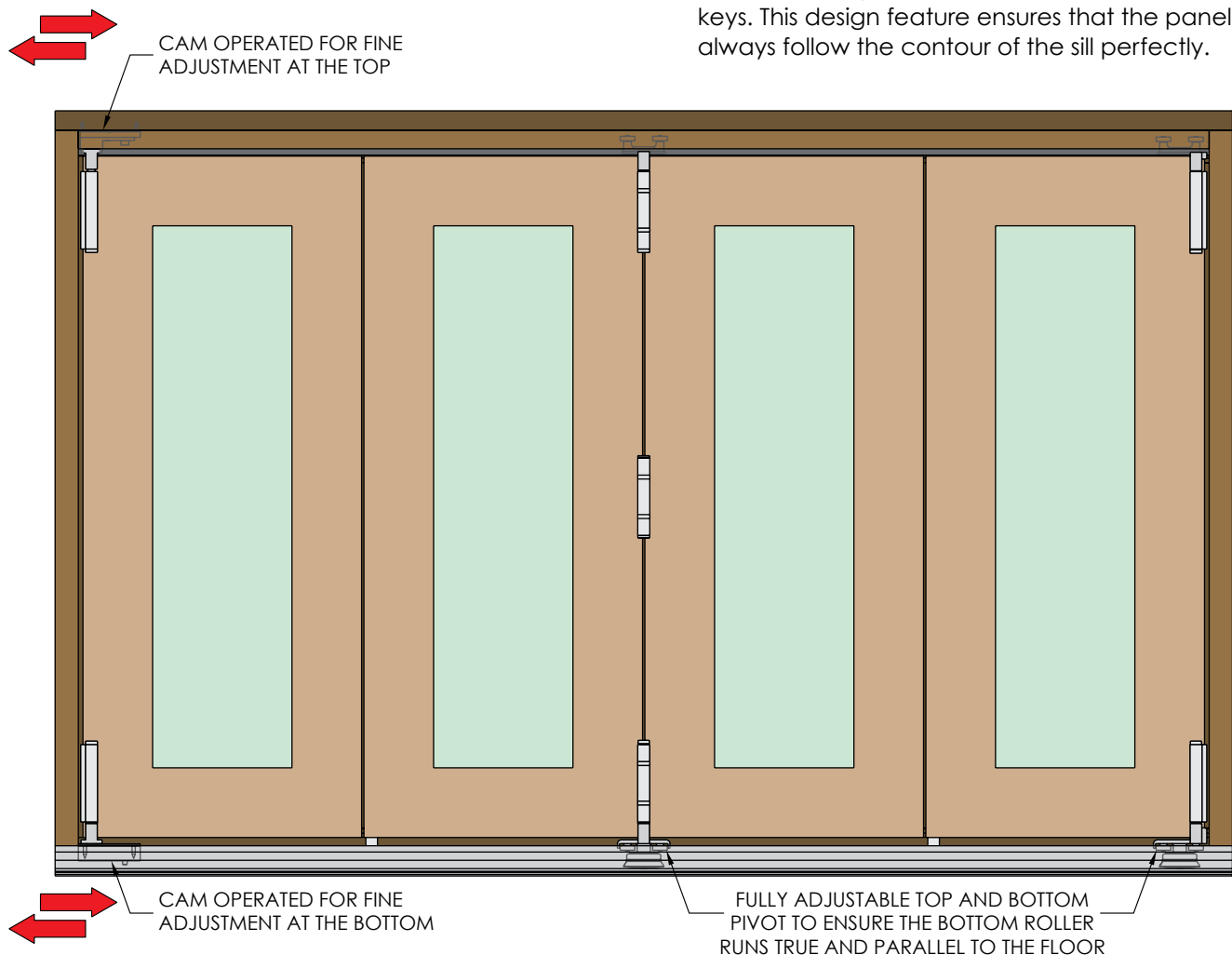



Accessories

Locking

Large, folding doors which connect the outdoors to your living space are a luxury but security is a necessity. Weatherfold 5c has therefore been designed to integrate with Brio's 286 dual point lock. This locking system operates on timber and aluminium panels to offer a single action handle as a stylish alternative to two flush bolts.

Brio's patented design can be used on Weatherfold 5c and single hinged panels (i.e. French doors). The 180° operation throws a shoot 22mm into the head and sill simultaneously for panels up to 3.5m high. Matching lever furniture 288, is also available with or without a built in magnetic catch. For more on Brio's 286 dual point lock visit Brio's website.

Brio 286 Dual Point Lock and 288 Lever Furniture





Adjustable Hinges

Brio's patented XY hinges are designed for 100kg aluminium and timber panels which are hinged to a jamb as a system or as an individual door. The discreet, surface fix design allows quick and easy installation and simple 2D adjustment of the panel which ensures the panel stays true to its perimeter seal and maintains weather performance.

189 Jamb Pivot

This discreet width adjustable product is an optional accessory that helps keep the pivot door parallel to the frame.

Brio XY Adjustable Hinge





Durability

Nothing carries the Brio brand without undergoing a rigorous test program and Weatherfold 5c is no exception. All components of Weatherfold 5c have passed endurance tests, so you can rest assured that Weatherfold 5c is built to last.

Corrosion resistance

Weatherfold 5c has completed extensive corrosion resistance tests conducted in an industry standard salt spray chamber.

Weatherfold 5c uses the highest quality corrosion resistant materials. All components are constructed using 300 series stainless steel, with the cast items in 316 grade.

Brio is one of only a few global companies to passivate all visual stainless steel surfaces and electro-polish all cast stainless components. These processes greatly reduce and eliminate surface discoloration often referred to as 'tea-staining'.

The Weatherfold 5c premium finish of Satin Stainless provides another level of protection from the elements and further enhances the system's durability.

Backed by Brio's 10 Year Warranty

Brio Weatherfold 5c uses only the highest quality materials and is the culmination of countless hours of research and development and rigorous product testing. Therefore Brio is pleased to offer a 10 year warranty on all Weatherfold 5c hardware. Refer to Brio's web site for details.



Weatherfold 5c 80

Hardware Layout - Non Mortice Hinge

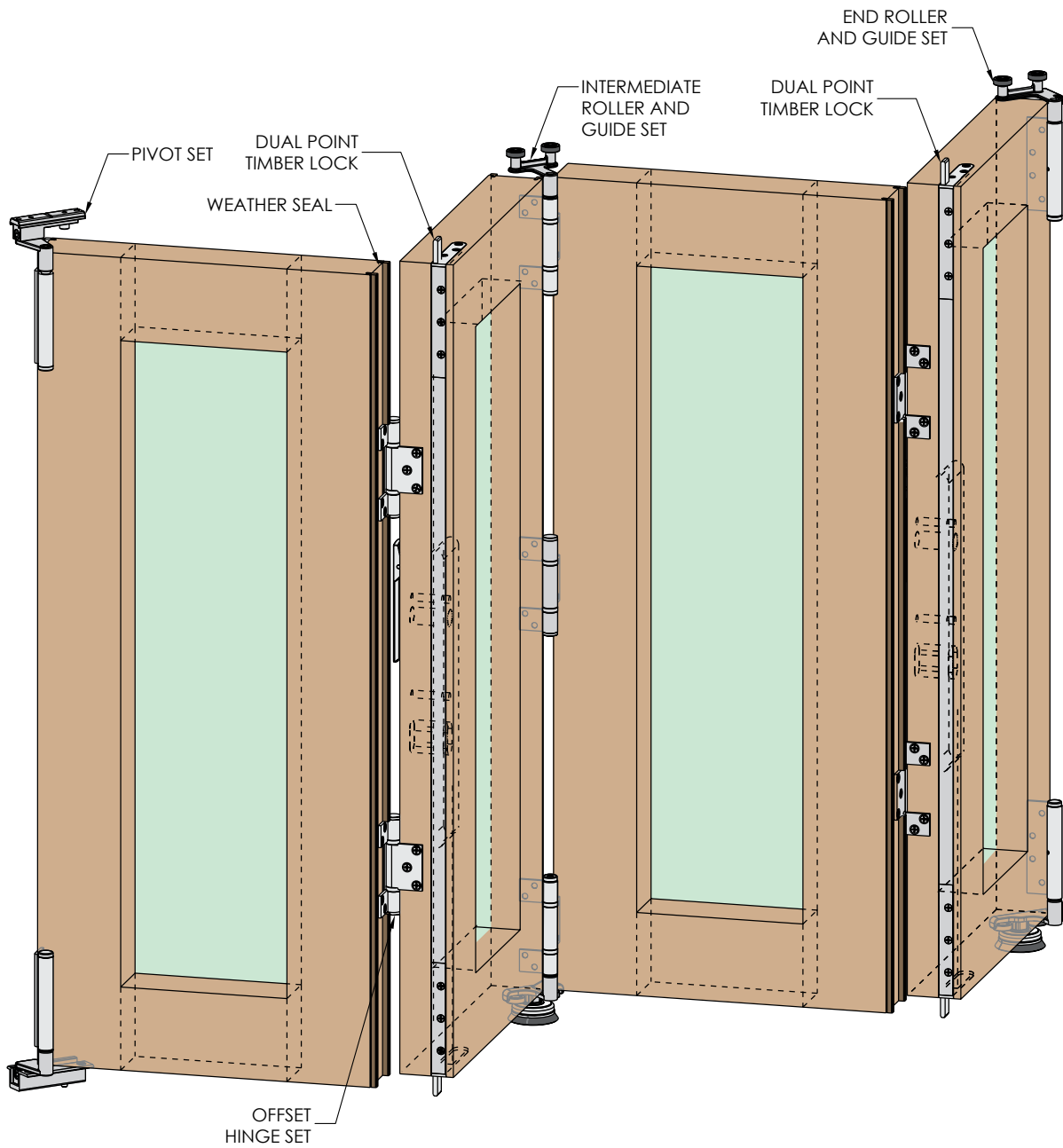

Weatherfold 5c 80

Top and Front Views - Non Mortise Hinges

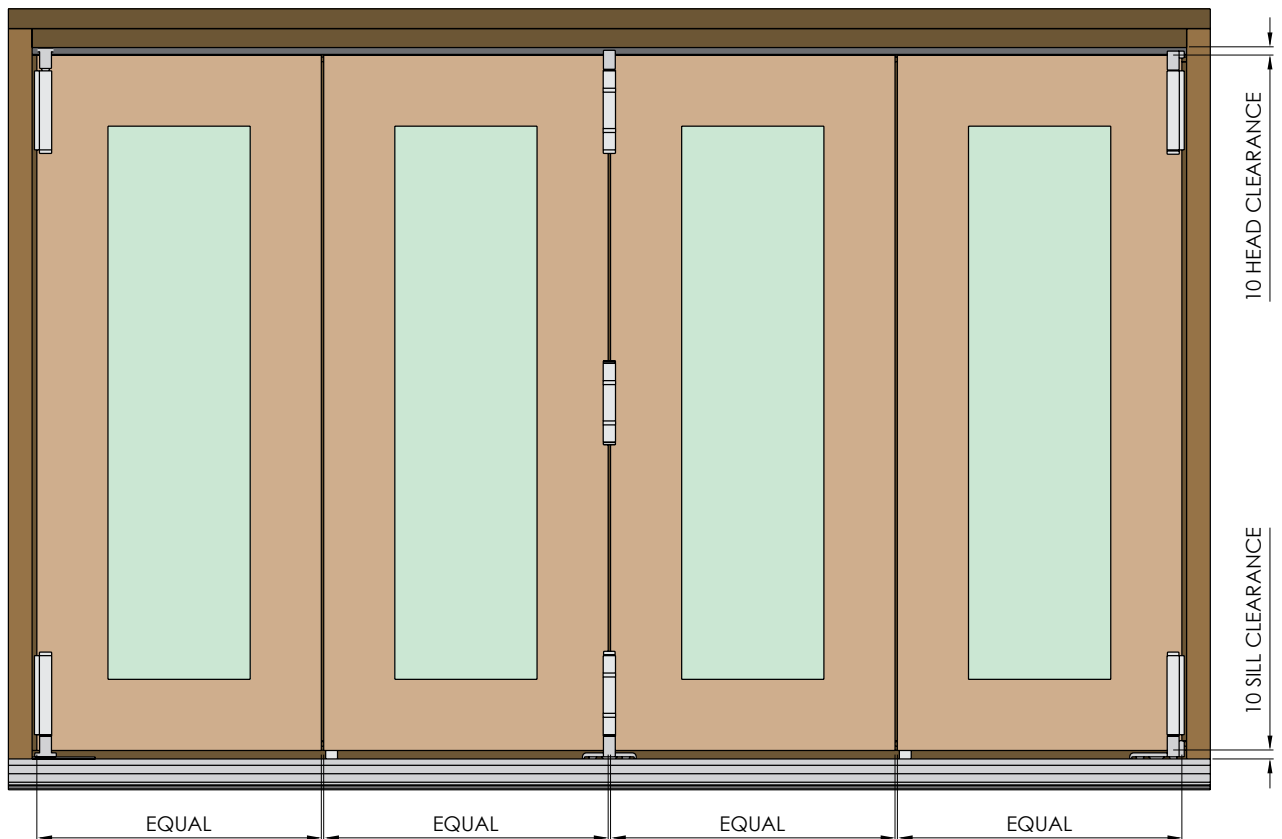
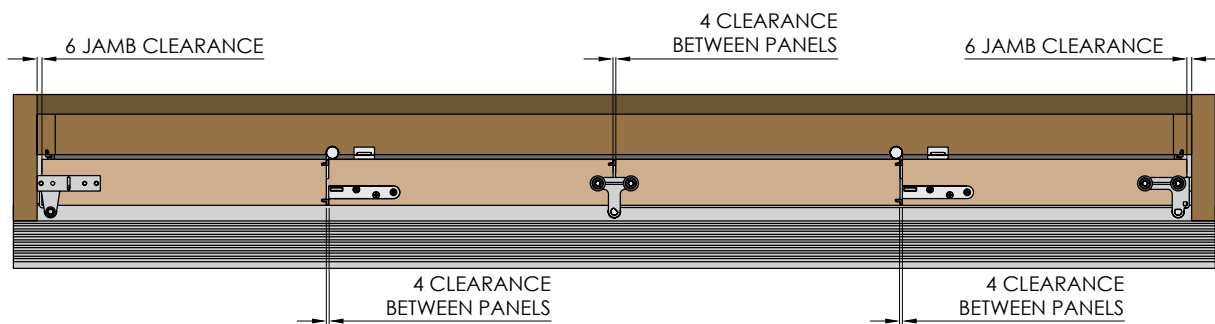
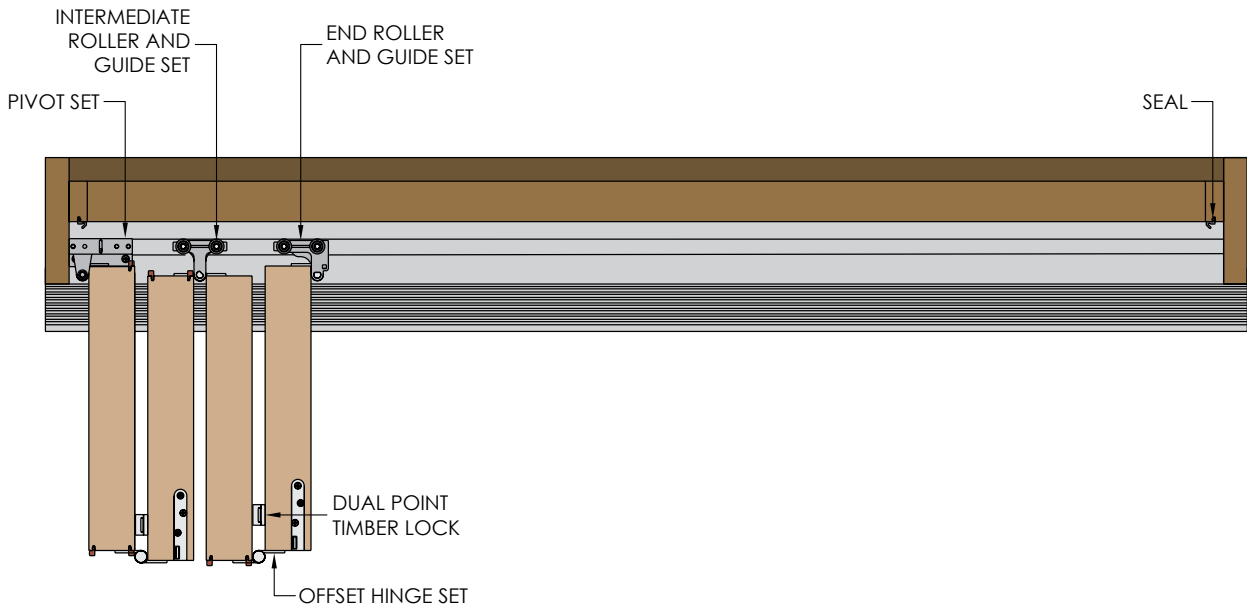

Weatherfold 5c 80

End View - Non Mortice Hinge

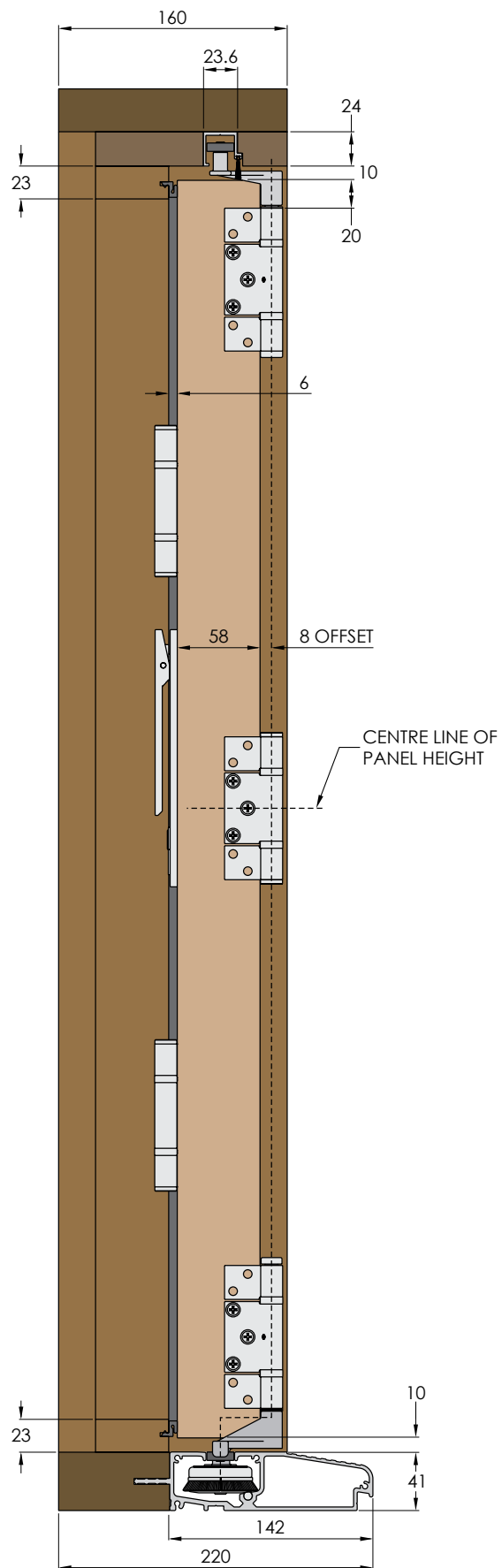

612 Integrated Retractable Pleated Insect Screen

Top View - Brio Weatherfold 5c 80

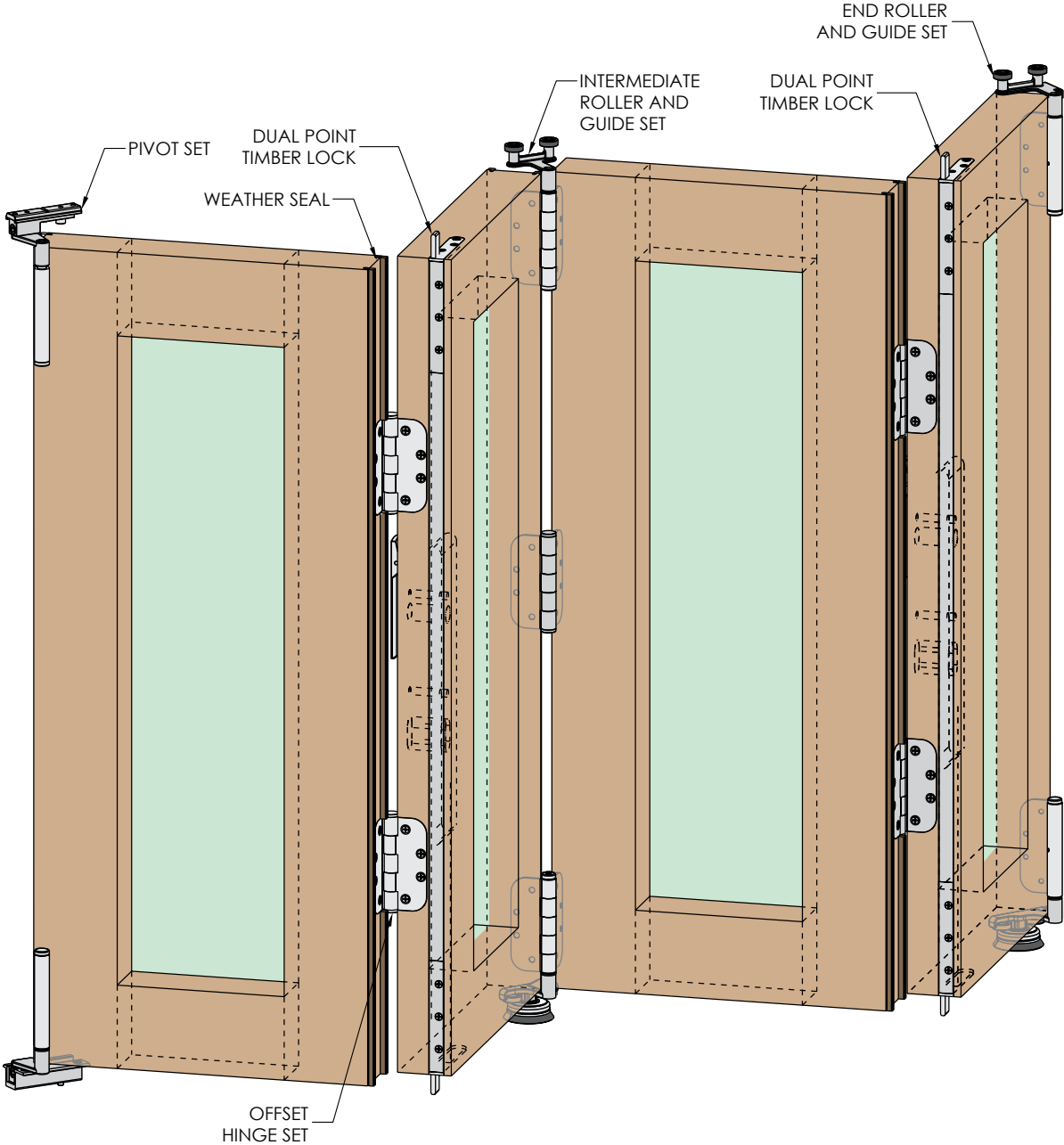

612 Integrated Retractable Pleated Insect Screen

End View - Brio Weatherfold 5c 80

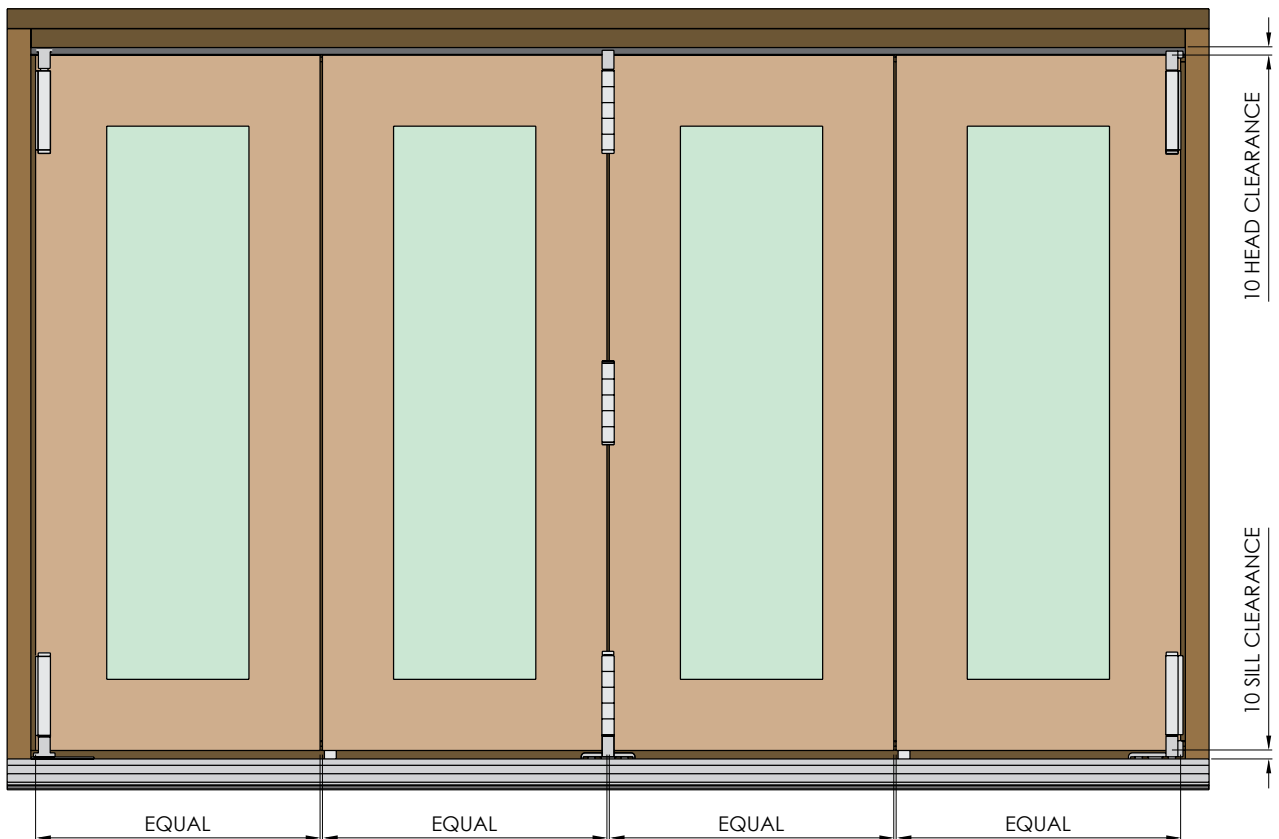
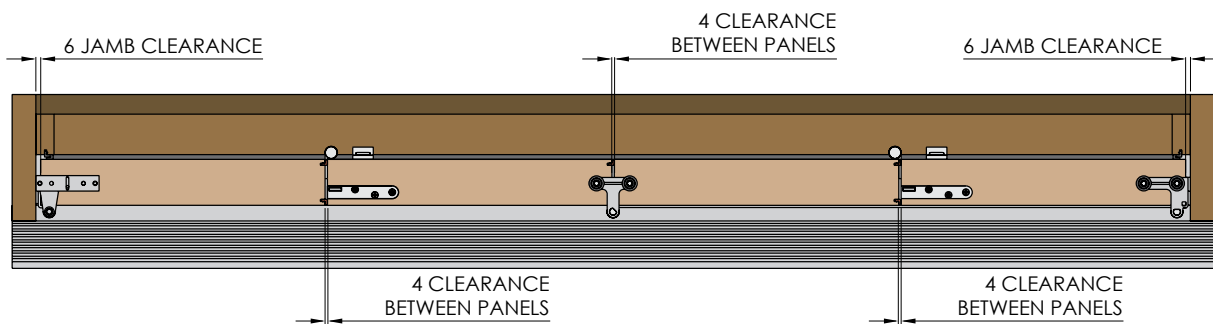
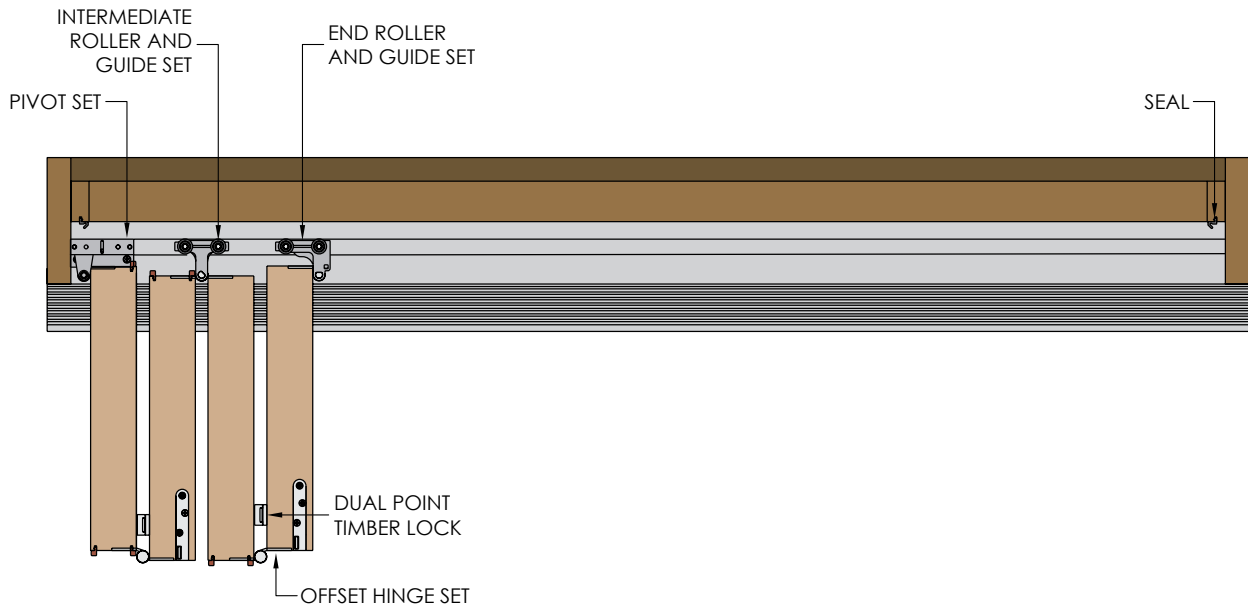

Panel Configuration and Hardware Location

Outward opening panels

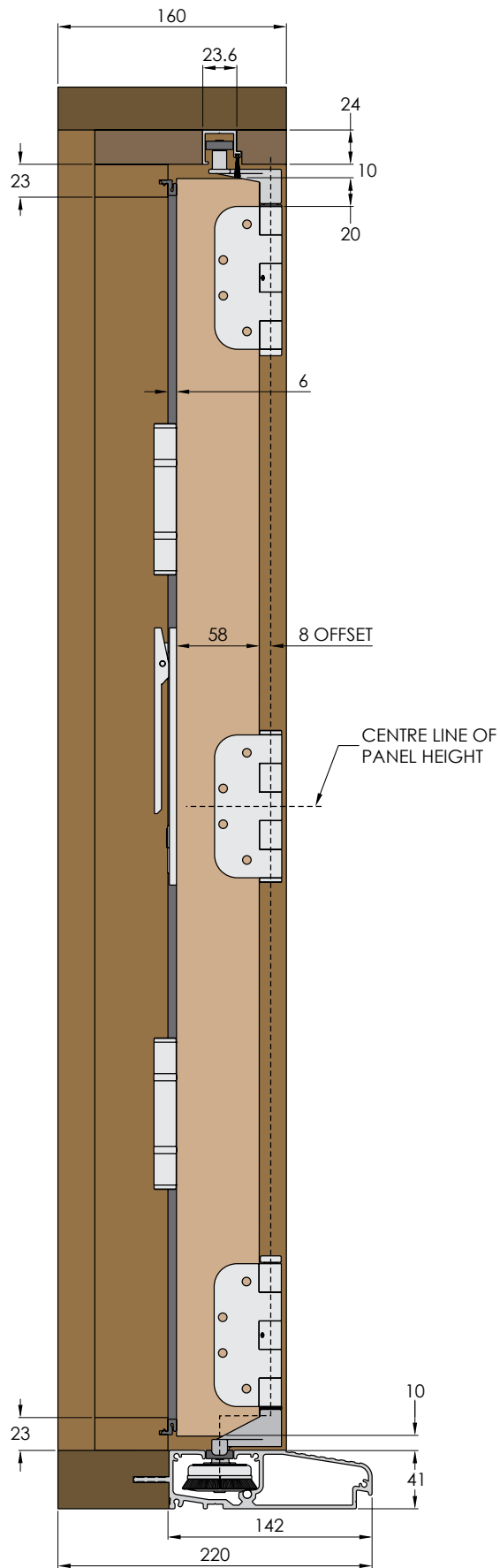

Panel Configuration and Hardware Location

Outward opening panels

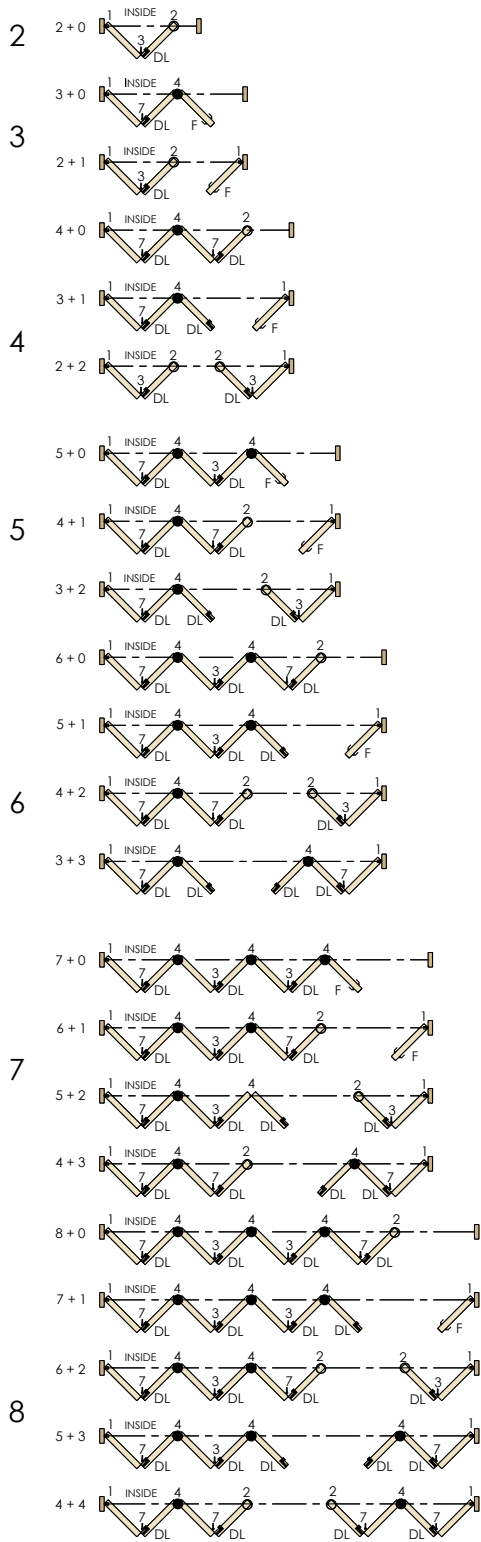

Panel Configurations Continued

HARDWARE LEGEND		
SYMBOL	REF.	DESCRIPTION
■	1	Adjustable pivot set
○	2	End roller set with guide
●	3	Hinge set with hinge handle
●	4	Intermediate roller set with guide
●	5	Hinge set
●	6	Offset hinge set
●	7	Offset hinge set with hinge handle
DL	DL	Dual Point lock
F	F	Lever Furniture handle set

The reference number is an abbreviation of the full set number

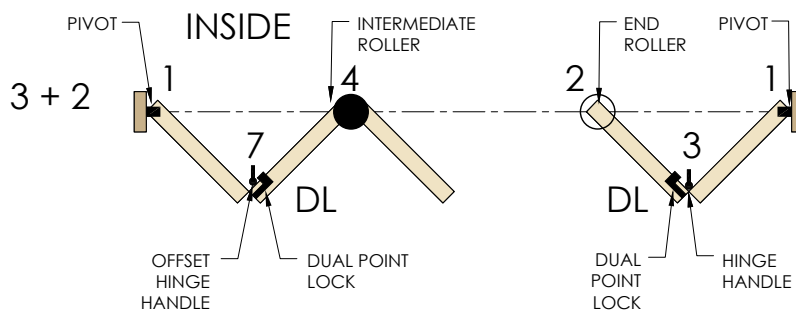

Meeting Panel Configurations

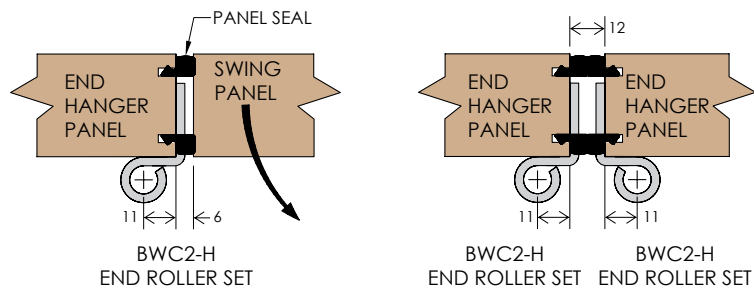

Brio®

Brio – Australia

PO Box 604, Chester Hill, 2162
C5 - C7, Regents Park Estate, 391 Park Road,
Regents Park, NSW 2143, Australia
Phone +61 2 8718 6718 Fax +61 2 8718 6719
www.brio.com.au
email: brío.sales@allegion.com

Brio – UK

Unit 30 Gateway West, Kingfisher Boulevard, Newburn Riverside,
Newcastle Upon Tyne, NE15 8NZ, United Kingdom
Phone +44 (0) 191 2291224 Fax +44 (0) 191 2677891
www.briouk.com
email: brío.sales.uk@allegion.com

Brio – USA

85 Mushroom Blvd
Rochester, NY 14623-3201
Toll Free +1 855 586 6251 Phone +1 585 319 5599 Fax +1 585 319 5741
www.brioussa.com
email: brío.sales.usa@allegion.com

About Allegion

Allegion (NYSE: ALLE) is a global pioneer in the field of safety and security. We keep people and their property safe, wherever they are, bringing together simple solutions and advanced technology. Allegion is a \$2 billion company, with products sold in almost 130 countries. For more, visit www.briouk.com

